

RU

GB

INSTALLATION MANUAL
SKID PLATE FOR FUEL TANK



MP



CHANGAN CS75 FL 1,8 TURBO AT FWD

2020 -

28.4571V2

08/10/20

1/6



(RU) /
(GB) Location/Position Arrow

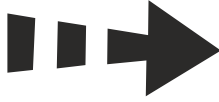



(RU)
(GB) Movement Arrow

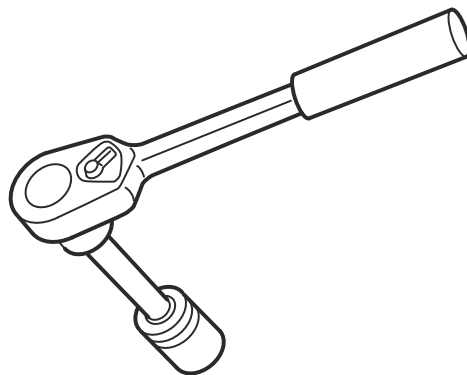
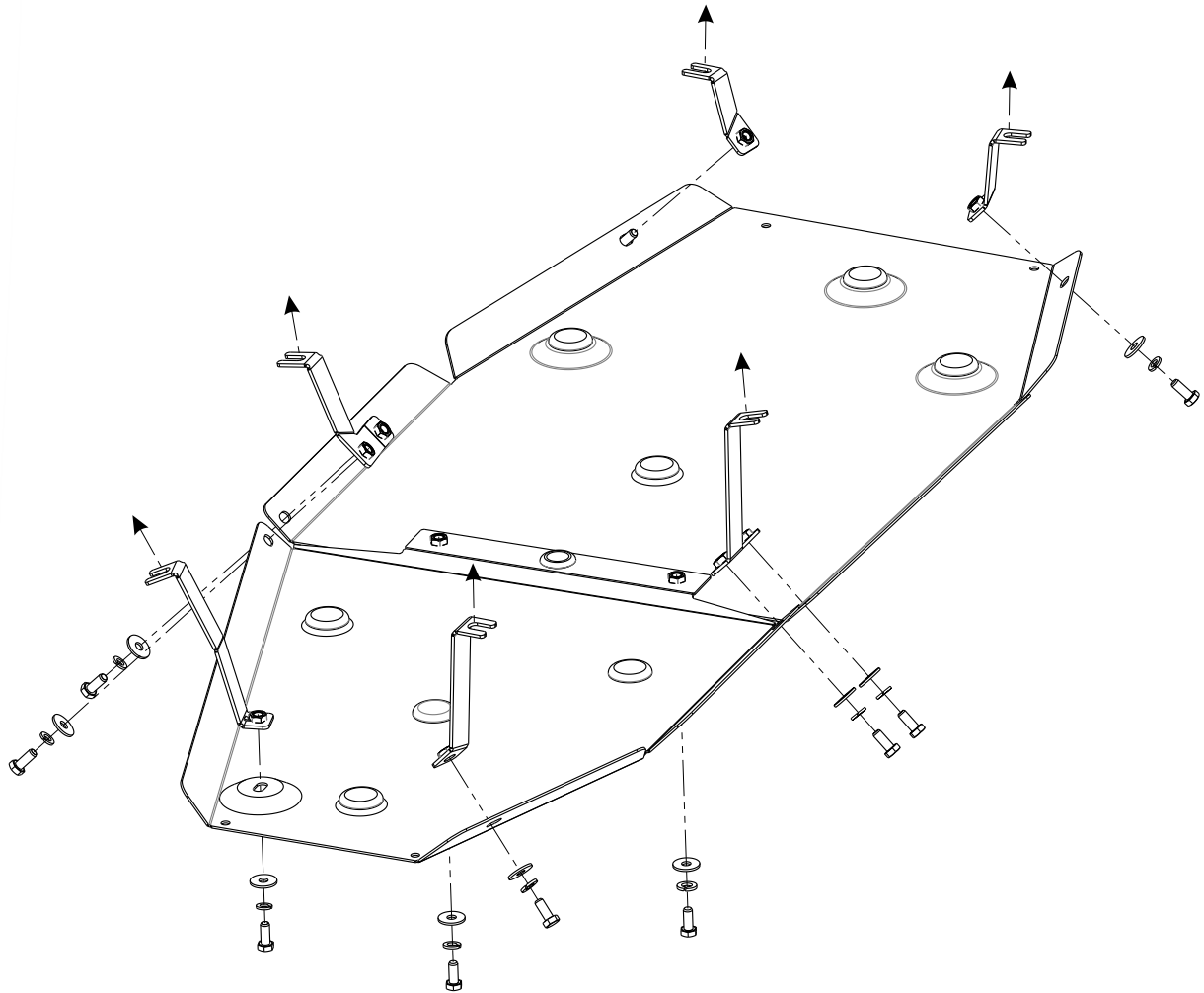

(RU)
(GB) Screw Arrow

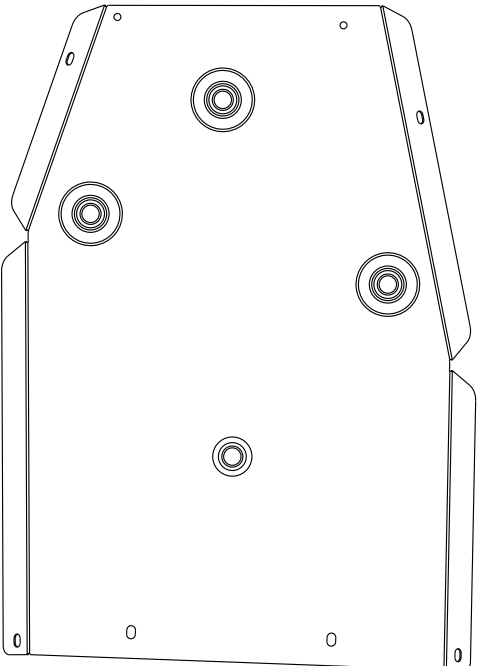
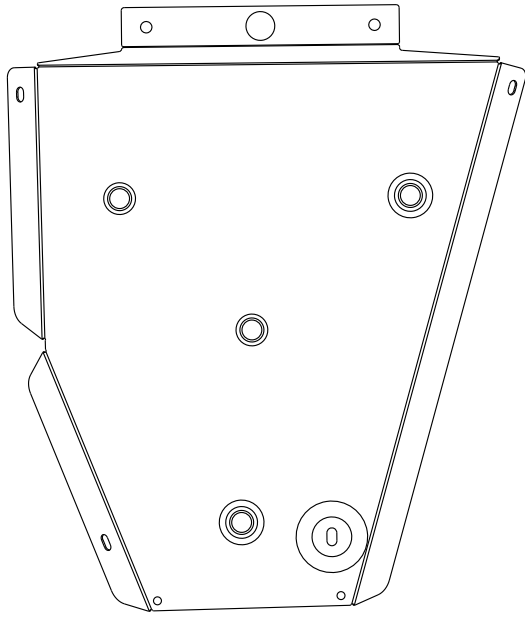
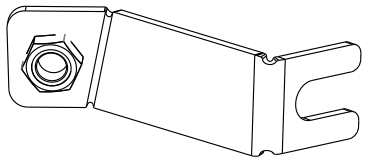
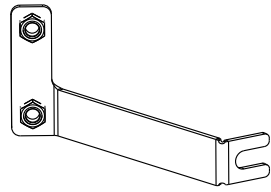
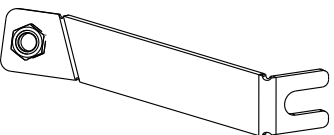
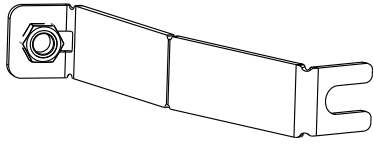
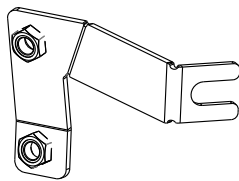
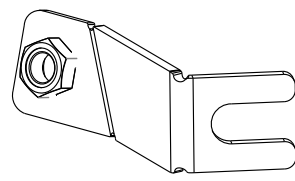
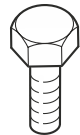
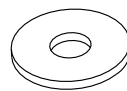
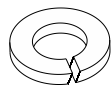

A1		A2	
	1X		1X
B			
	1X		1X
D		E	
	1X		1X
F		G	
	1X		1X
H	 <p>M8 20</p>	I	 <p>Ø8</p>
	10X		10X
J	 <p>Ø8</p>		
	10X		
 MP	28.4571V2		08/10/20
			3/6

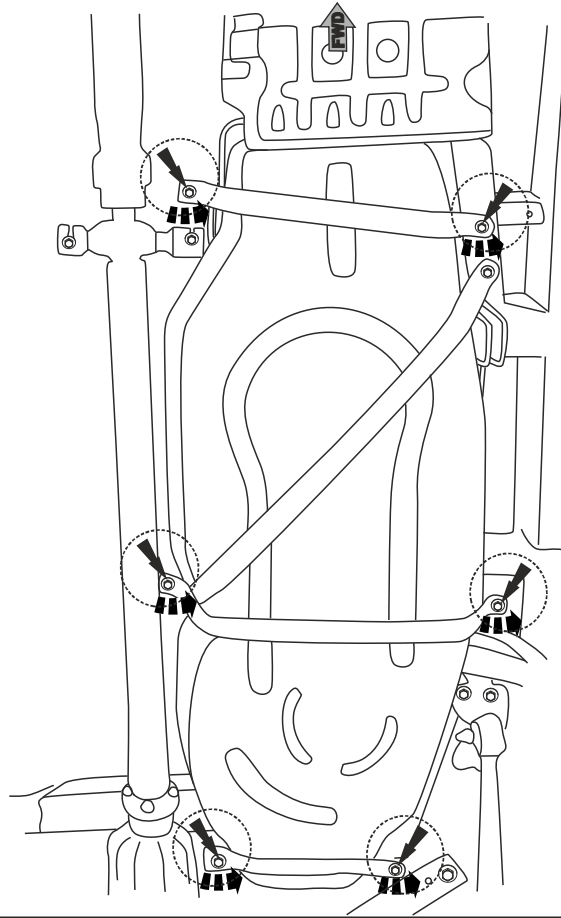

1

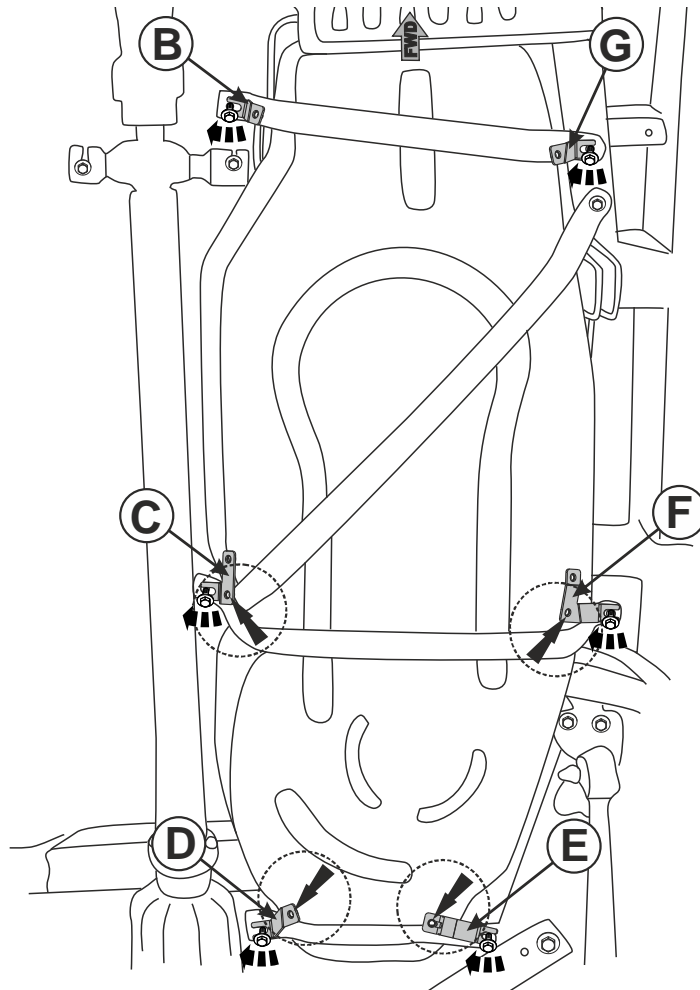

2

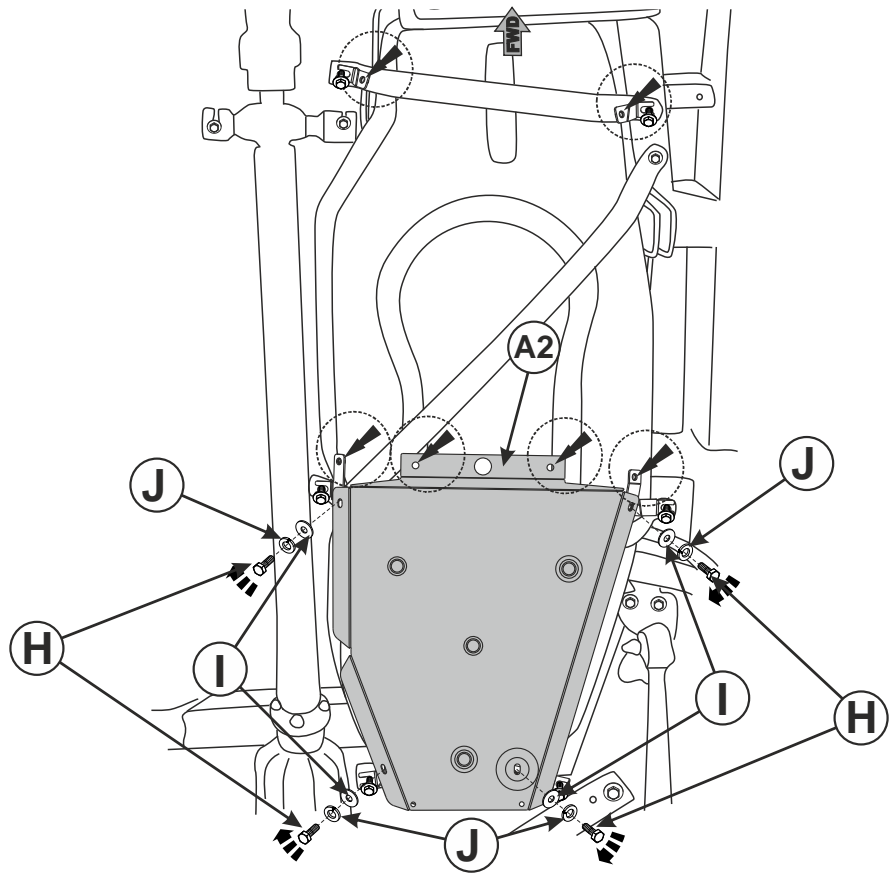

3

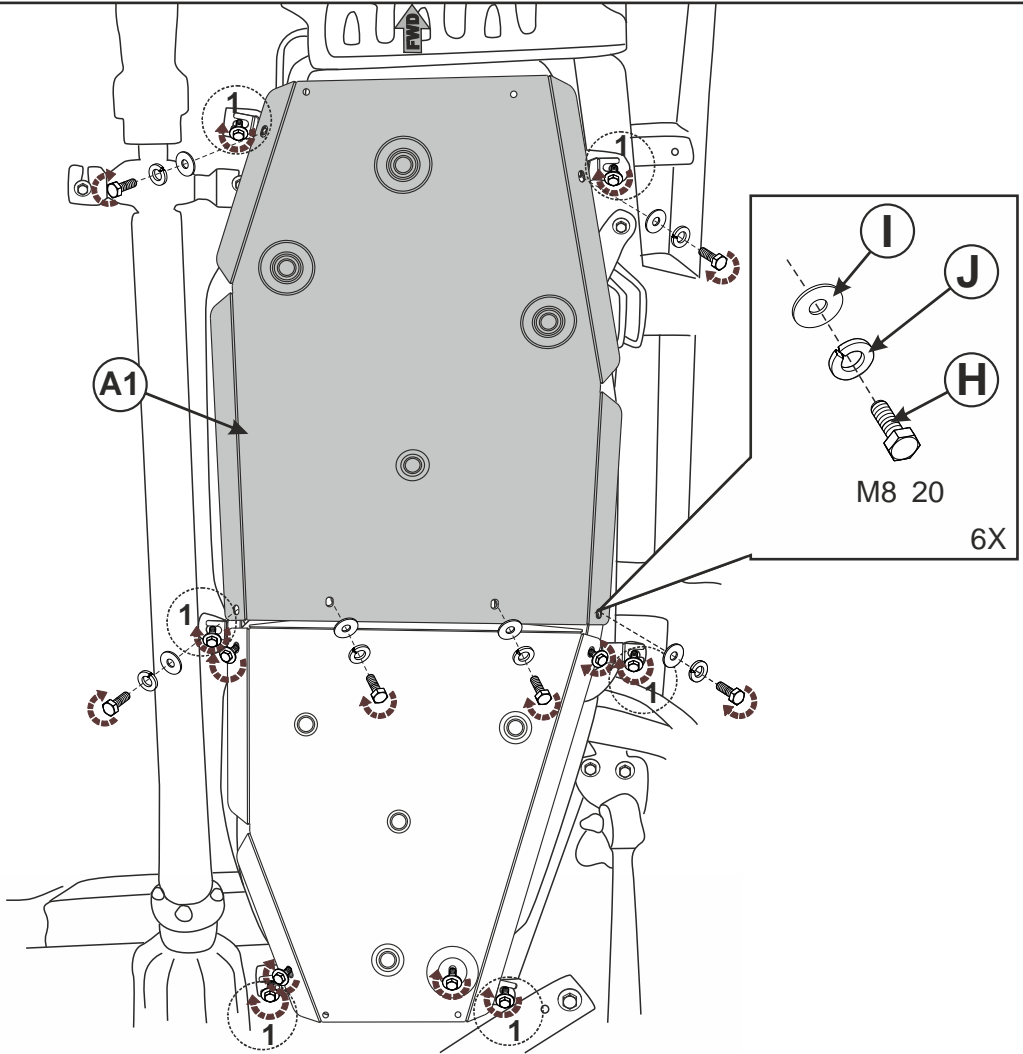
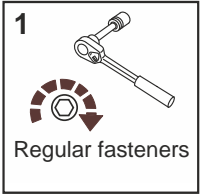
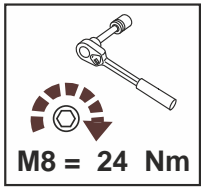

4



28.4571V2

08/10/20

5/6

