















- Accessory Installation

Note: Difficulty stated above reflects the minimum level of expertise required to install the accessory
(A) Customer (B) Dealer Technician (C) Master Technician

Instructional Symbols / Definitions

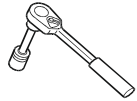
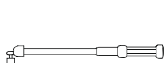
	Denotes warnings that may lead to serious physical injury or vehicle damage.		Denotes quality processes to be checked prior to moving to the next step.	Denotes safety equipment required to be used such as a mask, goggles, rubber gloves, and hearing protection.	
	Denotes cautions to be taken to avoid physical injury or electronic component damage.		Denotes specific tools that are necessary to complete the step.		
	Denotes cautions to be taken to avoid vehicle and component damage.		Denotes instructional steps necessary to complete the process.		
				Mask	Goggles
				Rubber Gloves	Hearing Protection

Basic Required Hand Tools

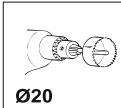
					
Torque wrench	Tighten	10 mm, 13mm, 17 mm	Extension	Cardan tool	Circular drill with cutters, d=20 mm

Notes to the Installer :

Read the entire installation pamphlet prior to beginning the installation of the accessory.

Ensure that the vehicle is properly protected in the area that the accessory is to be installed.

To prevent vehicle damage, never place tools on top of painted surfaces, seats, dash pad, console or floor carpet / mat.

Always wear appropriate safety gear to include gloves and eye protection when required.





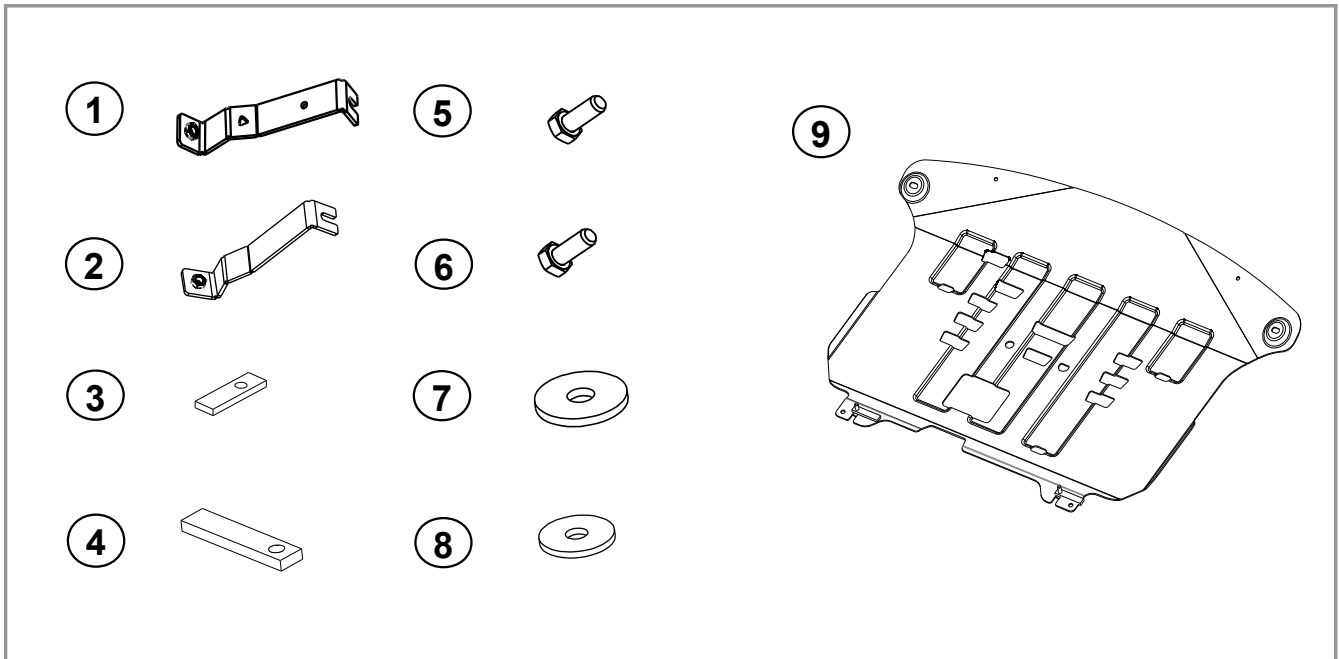

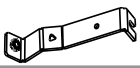
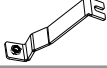

Ambient temperature of front body kit and vehicle must be 60°F ~ 110°F.

Kit Overview



No	QTY	Specification	No	QTY	Specification
1	1	Bracket			
2	1	Bracket			
3	2	SD 3003			
4	2	SD 3007			
5	2	Bolt M8x25			
6	4	Bolt M10x30			
7	2	Washer d=8			
8	4	Washer d=10			

Hardware Bag Overview

A		B		C		D		E	
1	Bracket	1	Bracket	2	SD 3003	2	SD 3007	2	Bolt M8x25
F		G		H		I			
4	Bolt M10x30	2	Washer d=8	4	Washer d=10	1	Installation instructions		

Hardware Kit Total
19

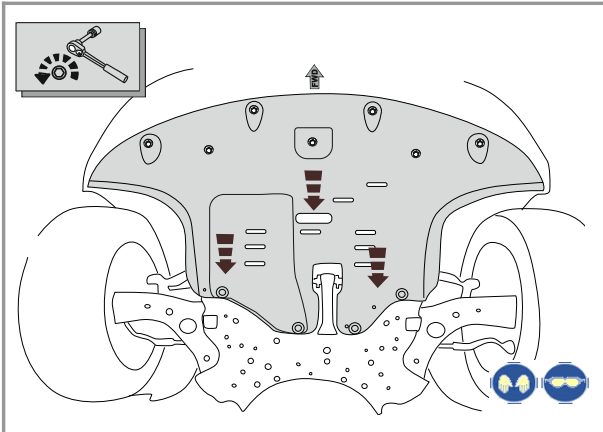

A torque wrench under regular fastener.

1

1. Remove the plastic duster. Do not remove them.

NOTE

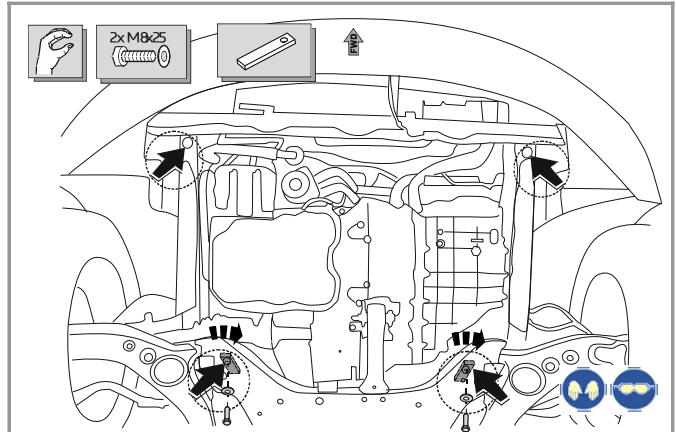

2

1. Install the SD 3007 (D) into the lower points of the subframe, loosely in them the bolts M8x25(E) with washer d=8(G).

NOTE

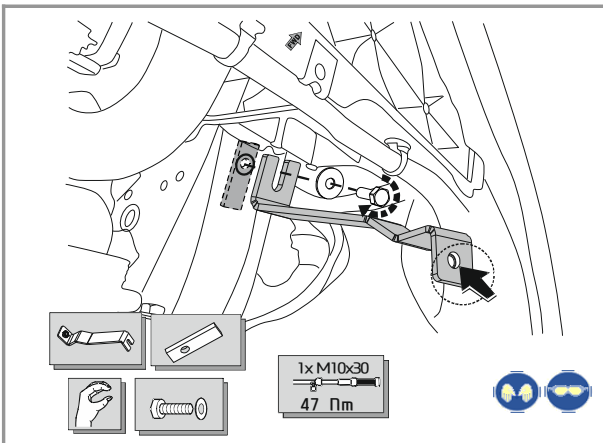

A torque wrench under 17 mm

3

1. Install the bracket (B) with SD 3003 (C), bolts M10x30(F), washer d=10 (H), set left. Tighten the screw.

NOTE

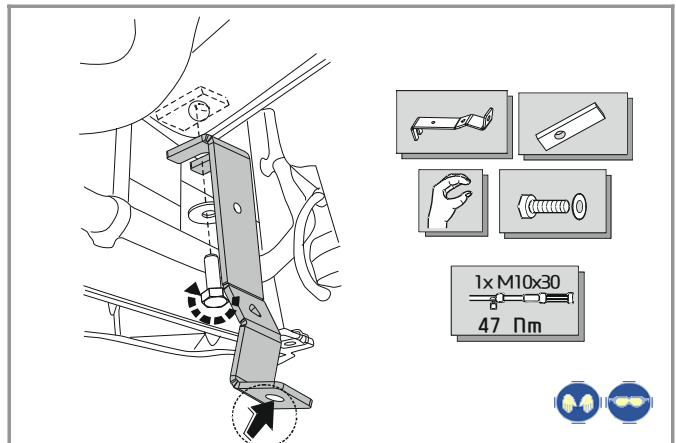

A torque wrench under 17 mm

1. Install the bracket (A) with SD 3003 (C), bolts M10x30(F), washer d=10 (H), set left. Tighten the screw.

NOTE

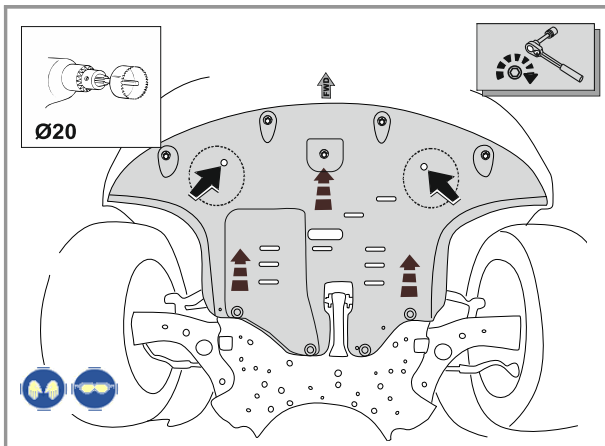

 Circular drill with cutters. A torque wrench under regular fastener. **5**

1. Install the plastic duster. 2. Drill the plastic duster in place, so you can see the holes, installed the brackets.

NOTE

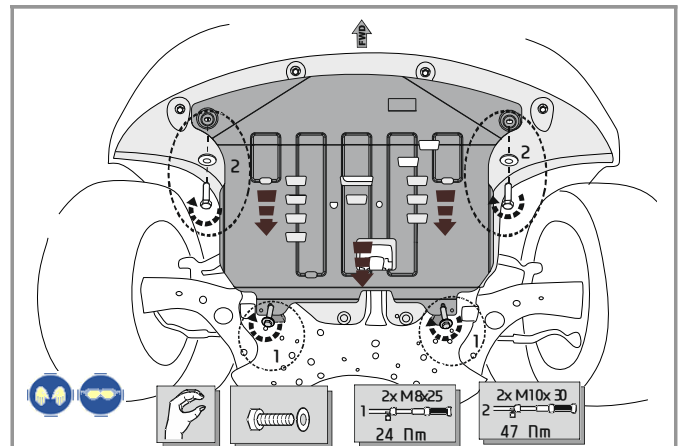

 A torque wrench under, 13 mm and 17 mm **6**

1. Install the skid plate into the lower points of the subframe. Fix the top points of the duster from the holes with bolts M10x30(F), washer d=10(H). Tighten the screw.

NOTE

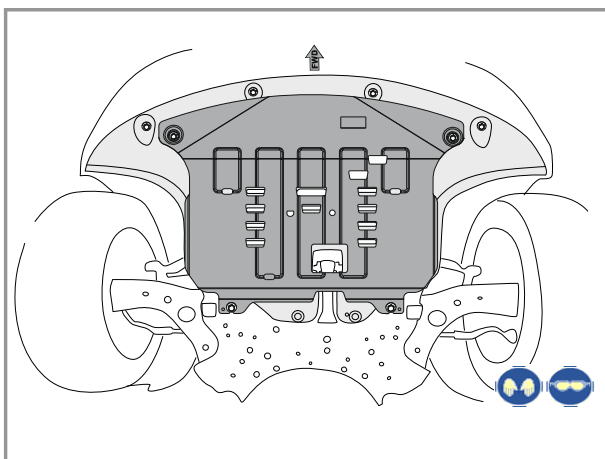

 **7**

1. Installation is complete.

NOTE