

RU

7 12 16 17 15 18 9 1 7 10 14 13 18 16 17 12 13 1 9 4  
6 4 7 17 9 15 17 4 15 7 9 14 14

GB

INSTALLATION MANUAL  
SKID PLATE FOR ENGINE BAY AND TRANSMISSION CASE



HONDA Stepwgn 1,5 AT FWD

2015 - 

09.4638/09.4639

14/08/20

1/6



RU ⑭513131186525171641916  
 GB Location/Position Arrow

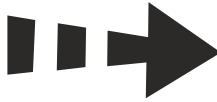

RU ③13171641916  
 GB Movement Arrow



RU ⑭51315759  
 GB Screw Arrow

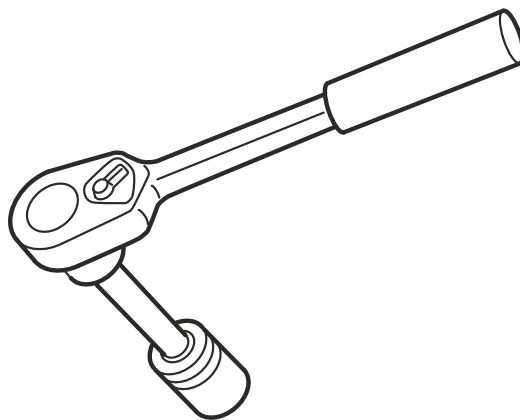
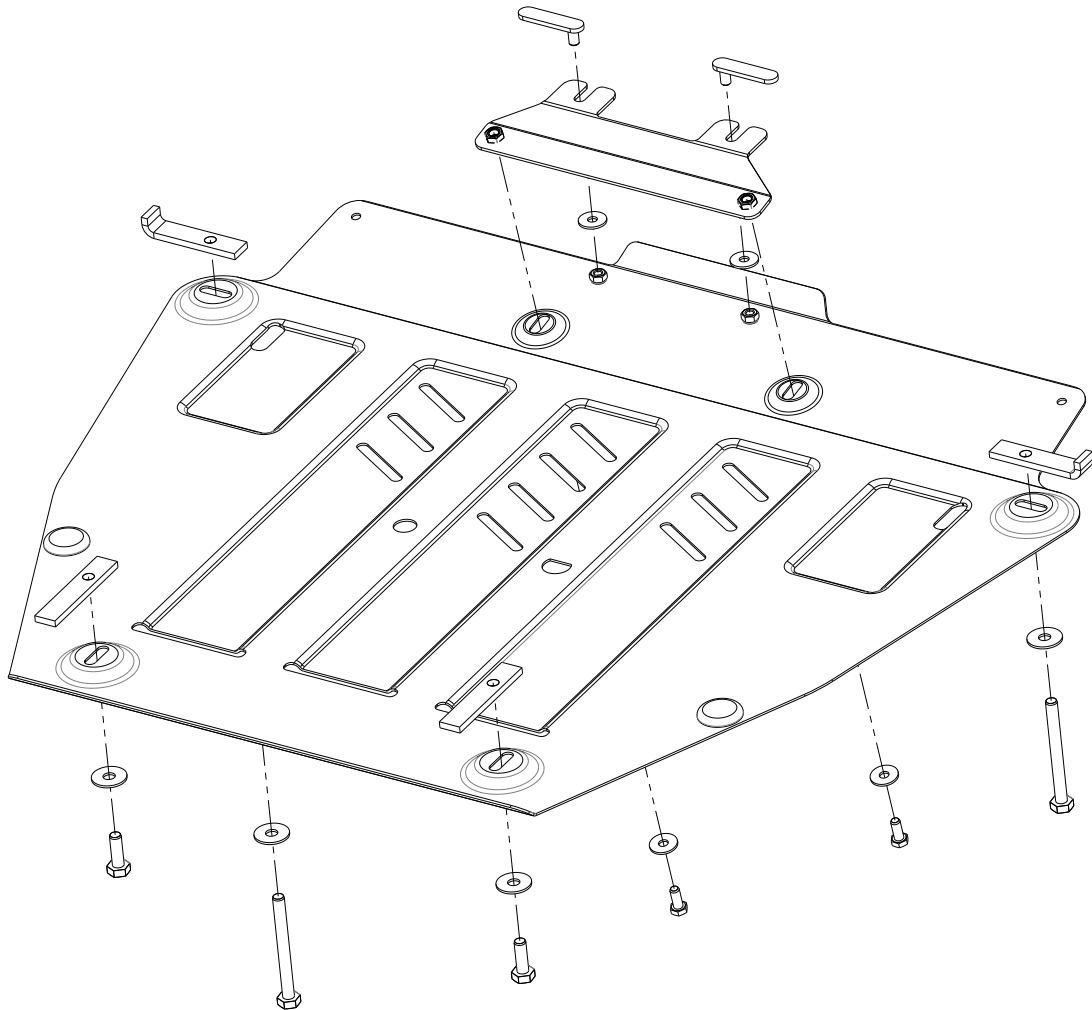

A

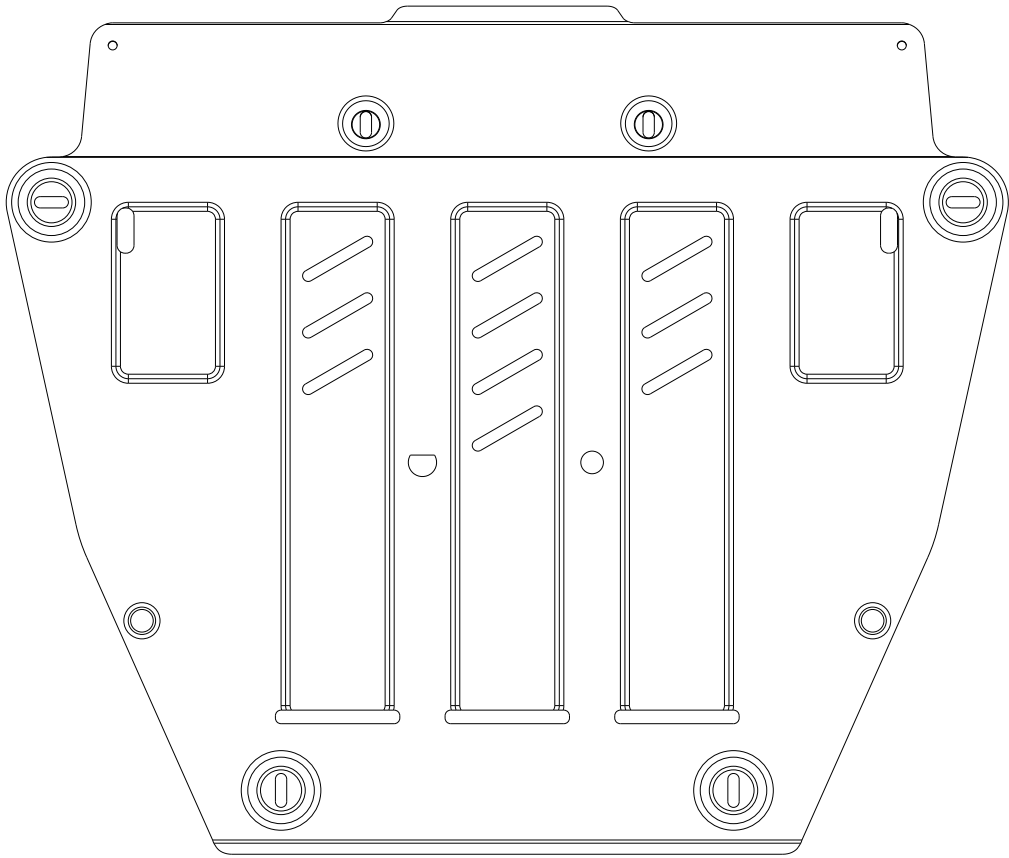

1X

B

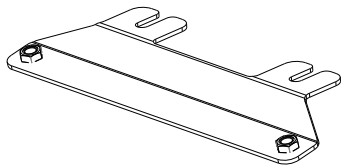

1X

16

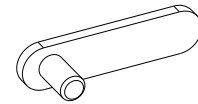

123 17003

2X

D

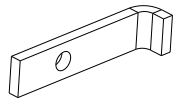

123 16001

2X

E

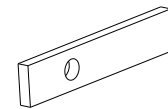

123 3004

2X

F

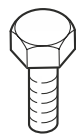

M1012100

2X

G

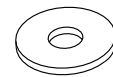

∅8

4X

H

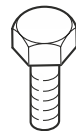

M8120

2X

I

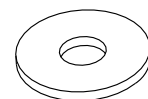

∅10

4X

J

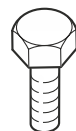

M101230

2X

K



M8

2X



09.4638/09.4639

14/08/20

3/6

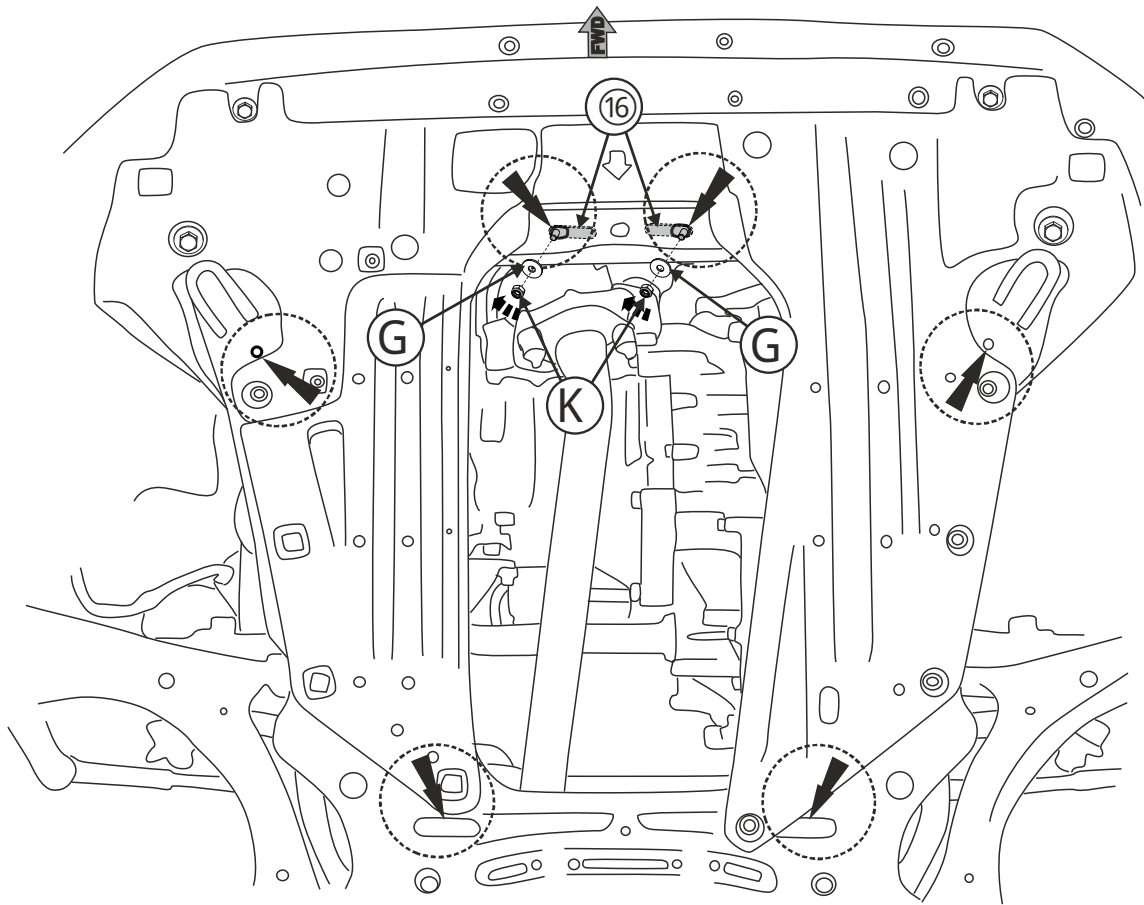

1

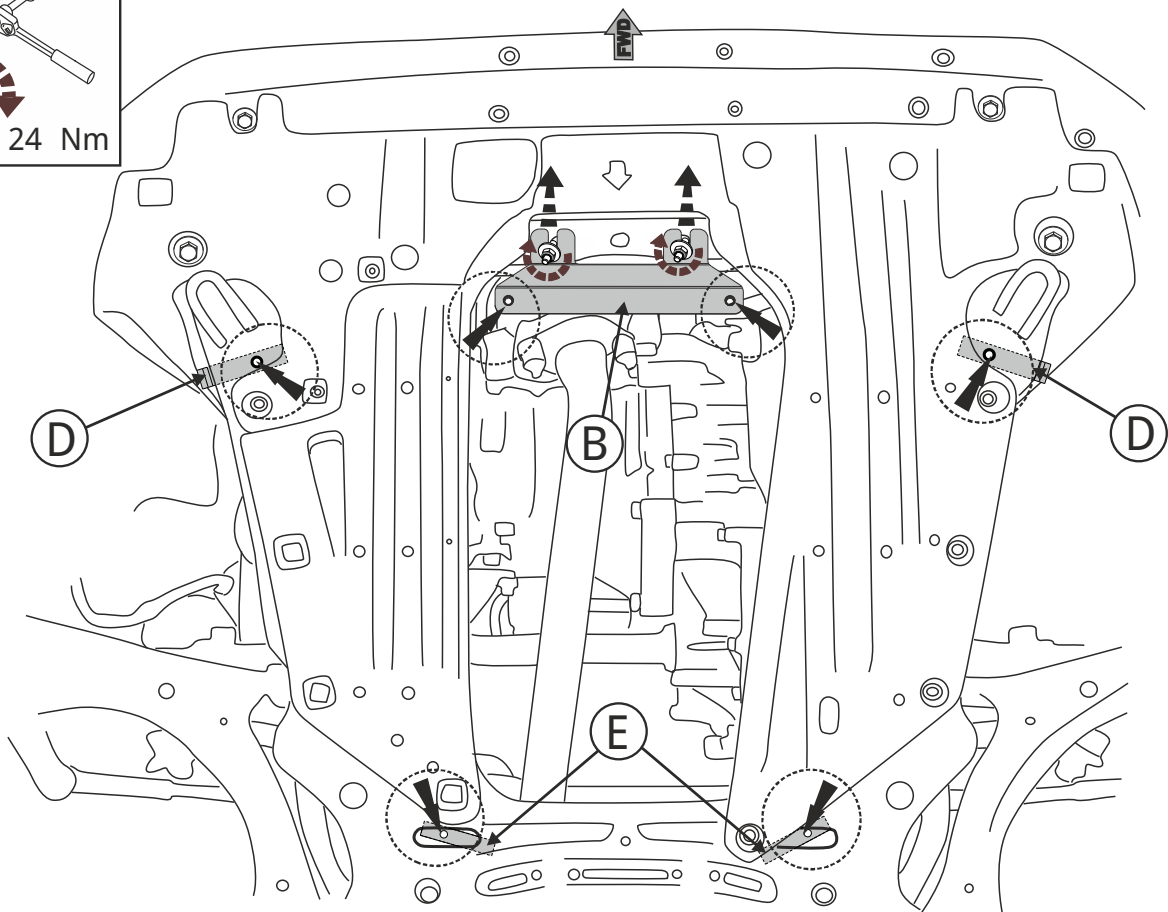
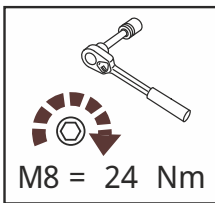

2

