

RU

GB

INSTALLATION MANUAL
SKID PLATE FOR ENGINE BAY



JAC T6 2,0 T MT 4WD

2020- 

28.4710/28.4711

1510/20

1/6



(RU) /
(GB) Location/Position Arrow

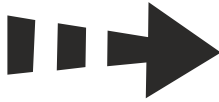

(RU)
(GB) Movement Arrow



(RU)
(GB) Screw Arrow

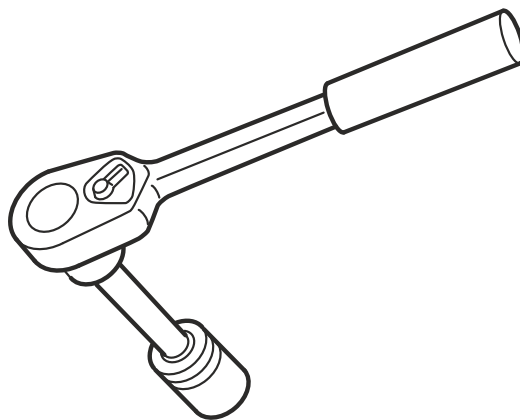
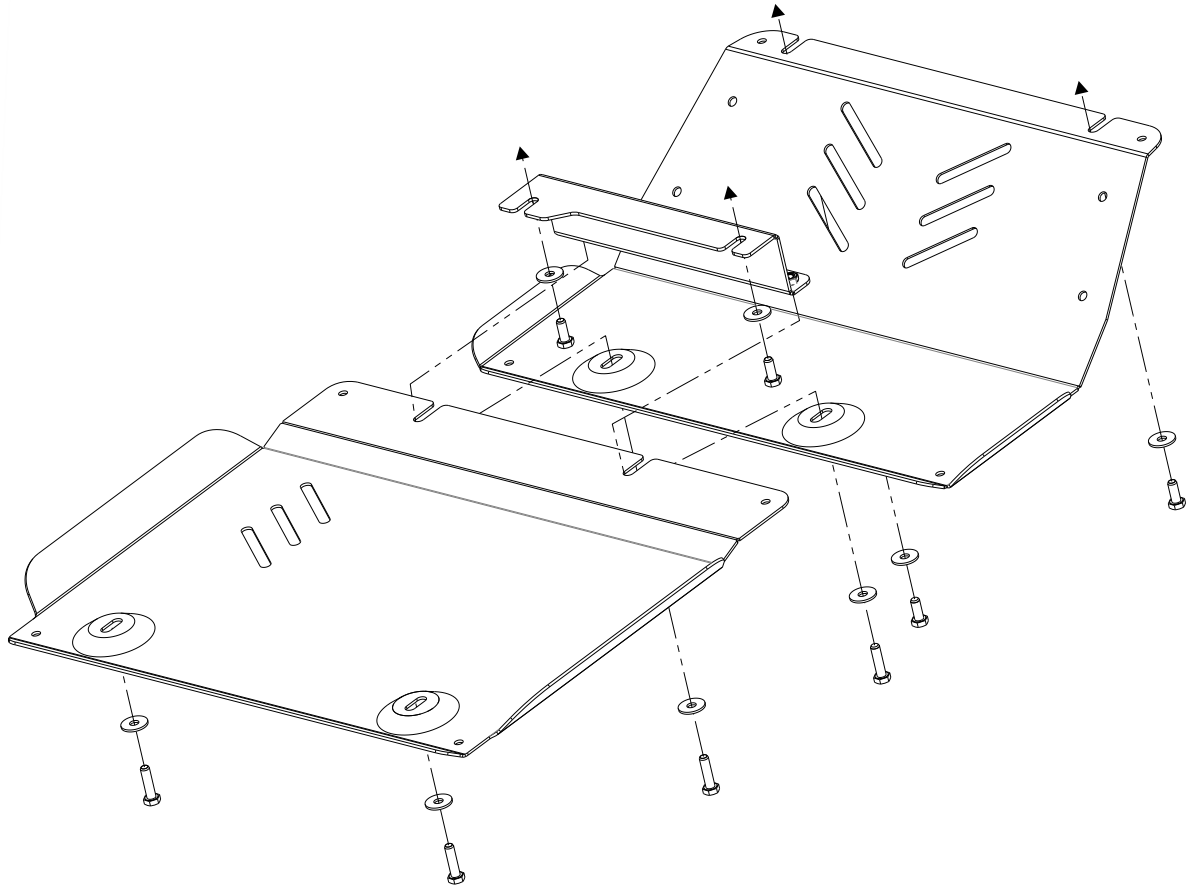

A1

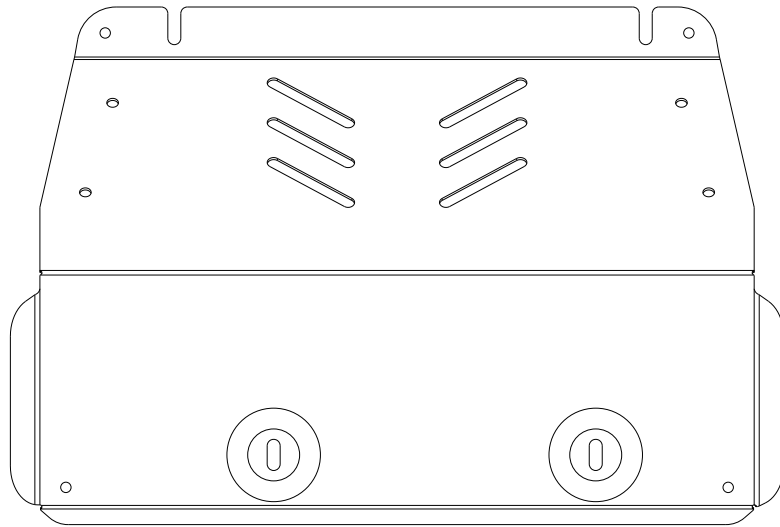

1X

A2

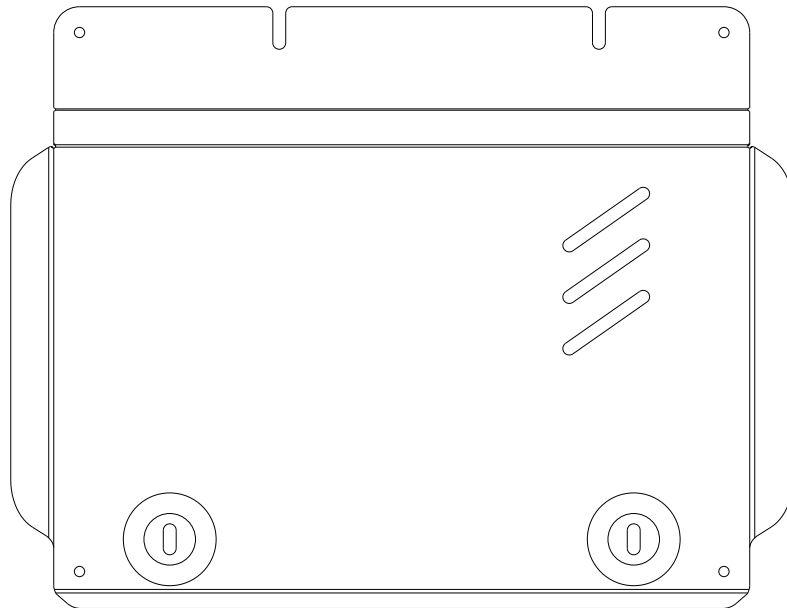

1X

B

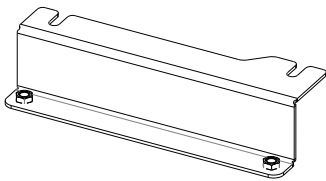

1X

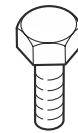

M8 20

4X

D

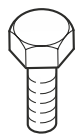

M8 30

4X

E

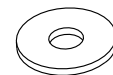

Ø8

8X



28.4710/28.4711

15/10/20

3/6

